

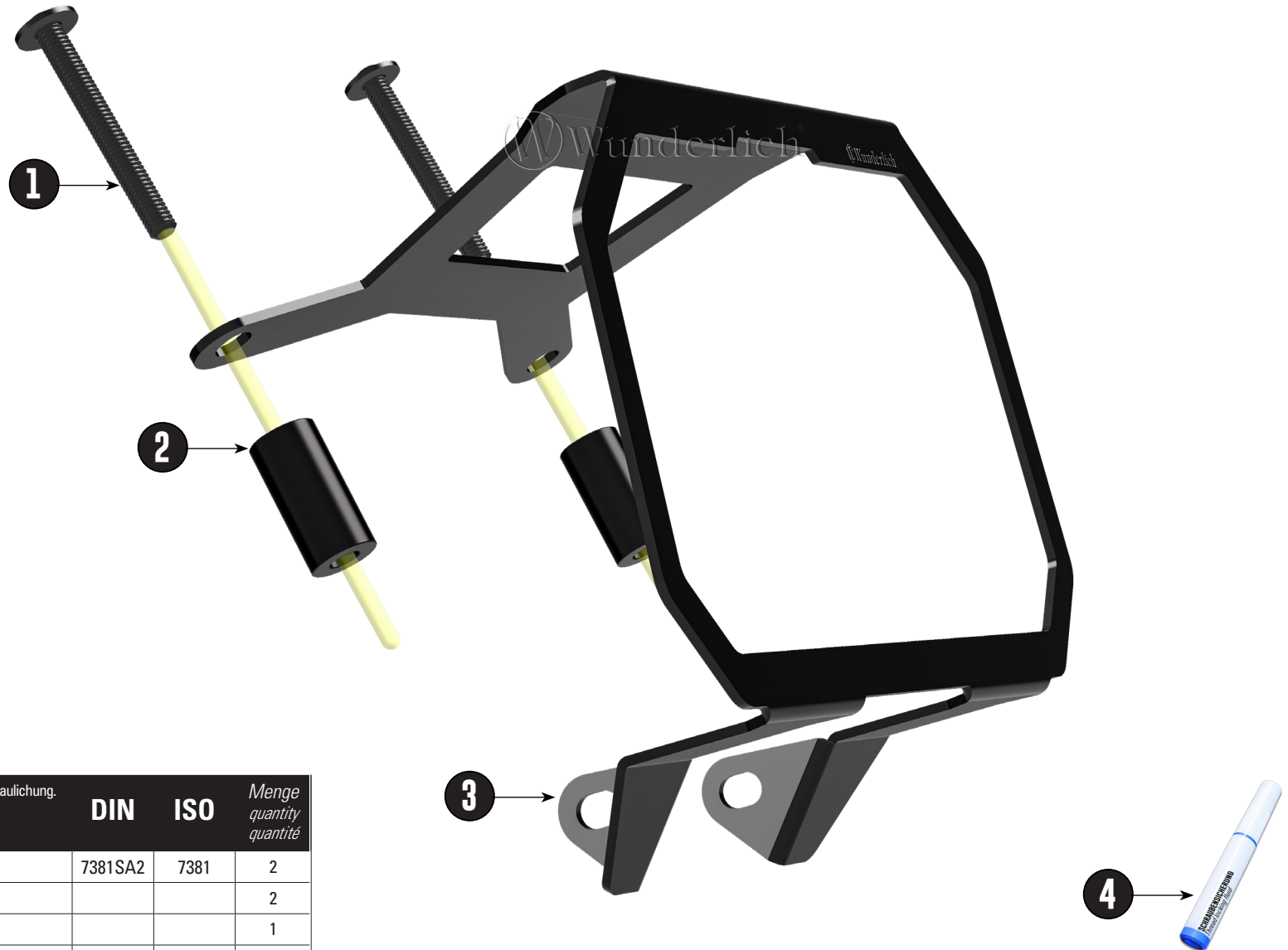







# TFT-DISPLAY DIEBSTAHLSCHUTZ

TFT Display Theft Protection | Protección antirrobo de la pantalla TFT | Protection antivol pour écran TFT | Protezione antifurto per display TFT

Art.-Nr: **13233-002**



## LEGENDE/KEY/FILE LÉGENDE

-  **Anbau Tipp**  
Fitting tip  
Astuce de montage
-  **Achtung**  
Attention  
Attention
-  **Vergrößerung**  
Magnification  
Grossissement
-  **Montagepaste**  
Fitting lubricant  
Lubrifiant de montage
-  **Schraube**  
Screw  
Vis
-  **Schraubensicherung**  
Thread locking fluid  
Freiniflets
-  **Drehmoment**  
Torque  
Torque
-  **Reiniger**  
Cleaner  
Nettoyant

#	Bauteil <i>component</i> <i>composant</i>	DE Die Farben der Abbildungen dienen nur der Veranschaulichung. EN The colors are for illustrating purposes only. FR Les couleurs utilisées sont à titre indicatif seulement.	DIN	ISO	Menge <i>quantity</i> <i>quantité</i>
1	Linseflanschschraube / Lens head screw	M6x55 (TX)	7381SA2	7381	2
2	Hülse / Sleeve	ØD 14,0 - Ød 9,0 - h 28,0mm			2
3	Displayschutz / Cover				1
4	Schraubensicherung / Thread locking fluid				1



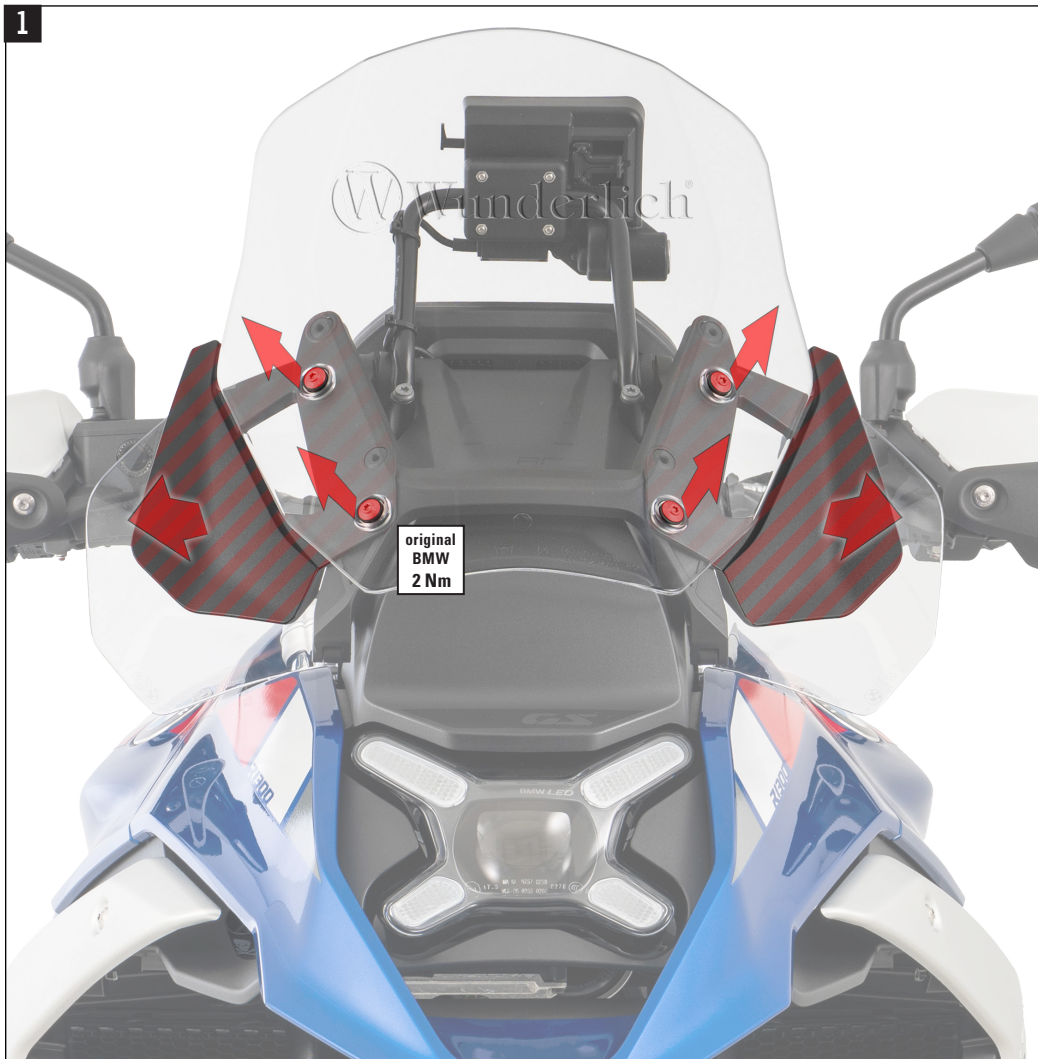

**DEMONTIEREN SIE, WINDSCHILD UND WINDABWEISER. DIESE WERDEN ZULETZT WIEDER MONTIERT (BILD 1). SCHRAUBEN DES NAVI HALTERS ENTFERNEN, DIE ANSCHLÜSSE MÜSSEN NICHT ENTFERNT WERDEN (BILD 2).**

**TIPP: LEGEN SIE EIN TUCH ODER ÄHNLICHES ALS KRATZSCHUTZ ÜBER DIE LENKERKLEMMUNG. NUN KÖNNEN SIE DEN NAVI-HALTER VORSICHTIG DARAUFGEBEN.**

*Remove the windshield adjustment cover or remove the navigation system bracket (Fig. 2). Remove the screws from the navigation system holder, the connectors do not need to be removed (Fig. 2).*

*Tip: Place a cloth or similar over the handlebar clamp to protect it from scratches. You can now carefully place the sat nav bracket on it.*

*Retirez le couvercle de réglage du pare-brise ou le support du système de navigation (Fig. 2). Retirez les vis du support du système de navigation, les connecteurs n'ont pas besoin d'être retirés (Fig. 2).*

*Conseil : Placez un chiffon ou une protection similaire sur le collier du guidon, sur lequel le support du système de navigation peut être placé avec précaution.*



**DIE BEIDEN OBEREN ORIGINALEN SCHRAUBEN DES FRONTRÄGERS DEMONTIEREN. DISPLAYSCHUTZ DER REIHE NACH MONTIEREN.**  
*Remove the two original upper screws of the front carrier. Fit the display protection in sequence.*  
*Retirer les deux vis supérieures d'origine du support avant. Monter la protection de l'écran dans l'ordre.*

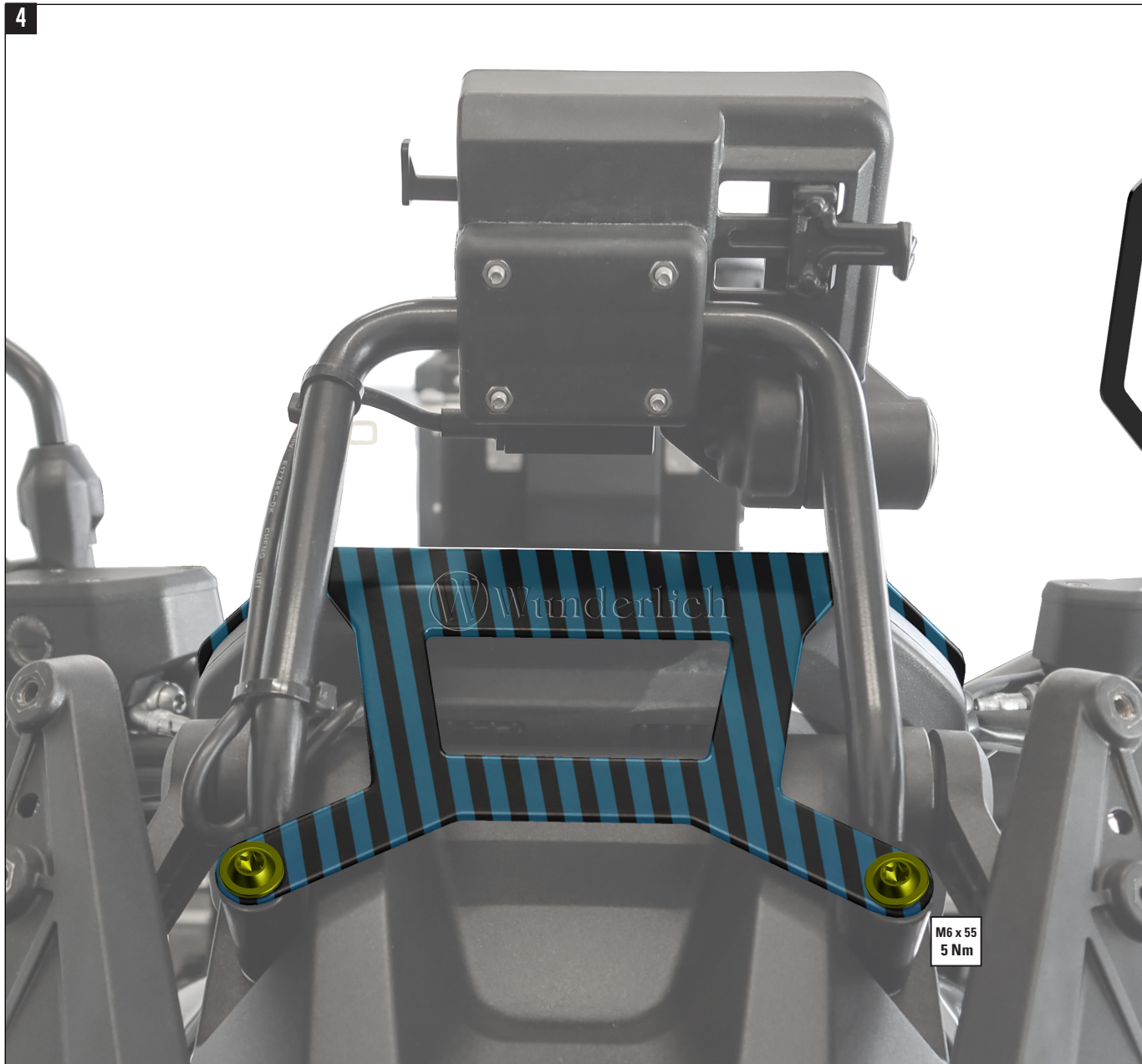

M6 x 55  
5 Nm



**HÜLSEN ENTFALLEN BEI DER MONTAGE MIT NAVI-HALTER.**  
*Sleeves are not required for mounting with navigation holder.*  
*Les manchons ne sont pas nécessaires pour le montage avec le support de navigation.*