



Lenkererhöhung

Handlebar risers

Riser manubrio

Risers de guidon

Canalizaciones verticales del manillar

Art.Nr.: 31040-20

50 Nm

40 Nm

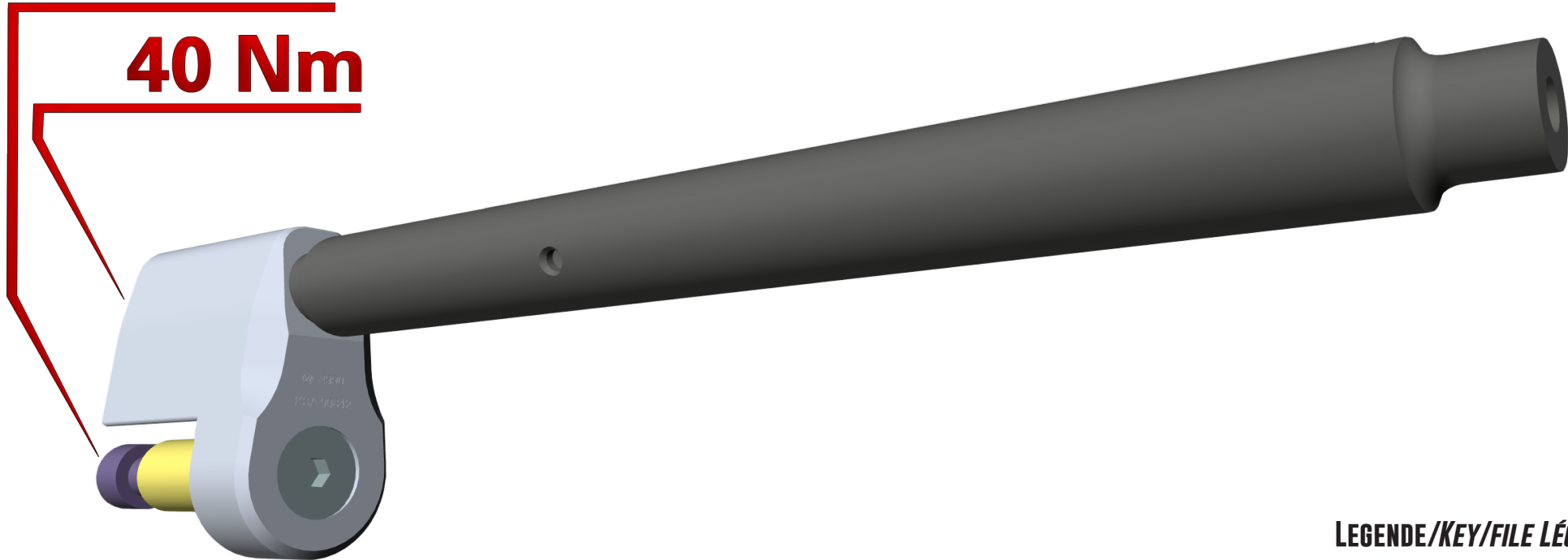

Legen Sie die Lenkererhöhung vor Beginn der Montage ins Gefrierfach.
Place the Handlebar risers in the freezer before beginning the installation.



LEGENDE/KEY/FILE LÉGENDE



Schraubensicherung
Thread locking fluid
Freinfilets



Anbau Tipp
Fitting tip
Astuce de montage



Entfernen Sie die Abdeckung 1, danach lösen Sie die Stecker 2.

Remove cover 1, then unplug the connectors 2.

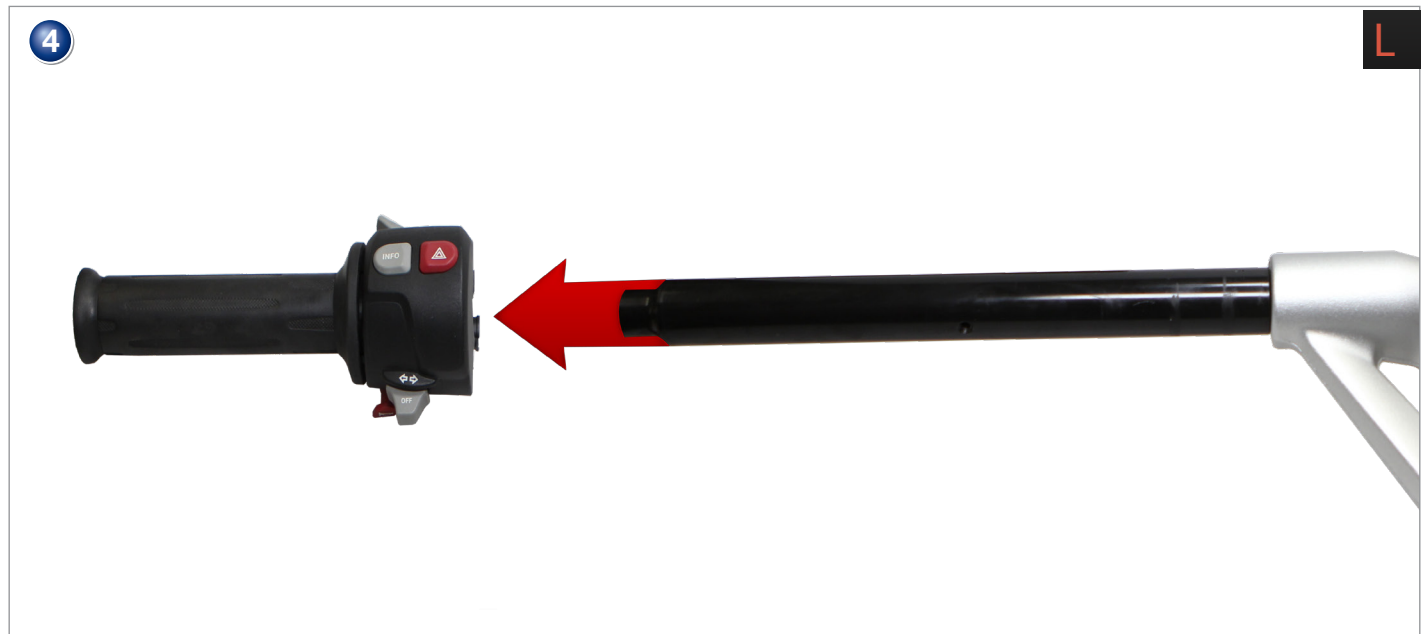

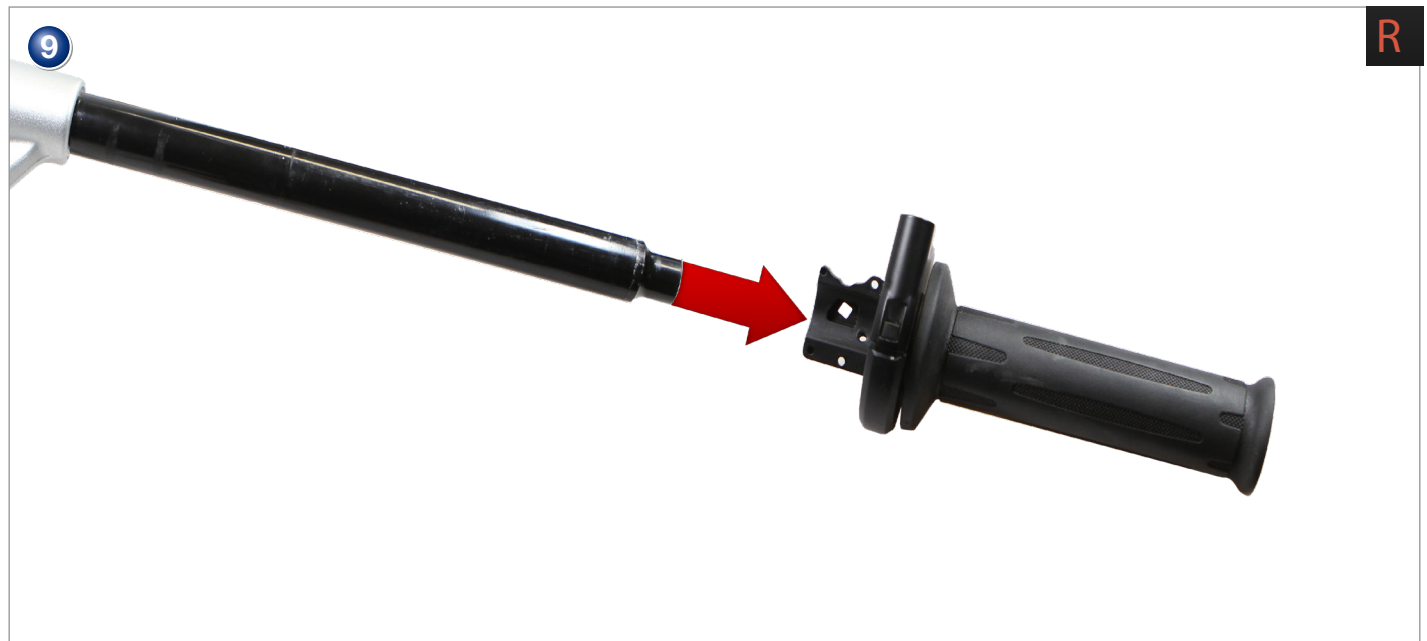
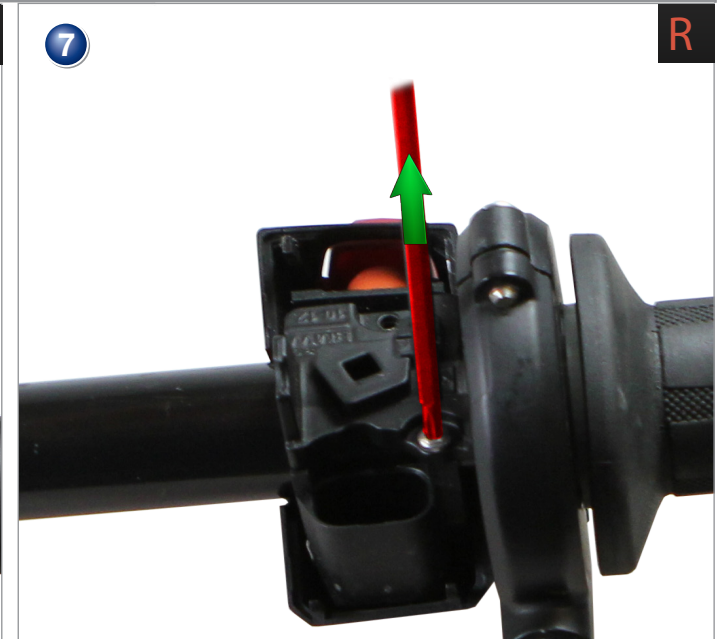
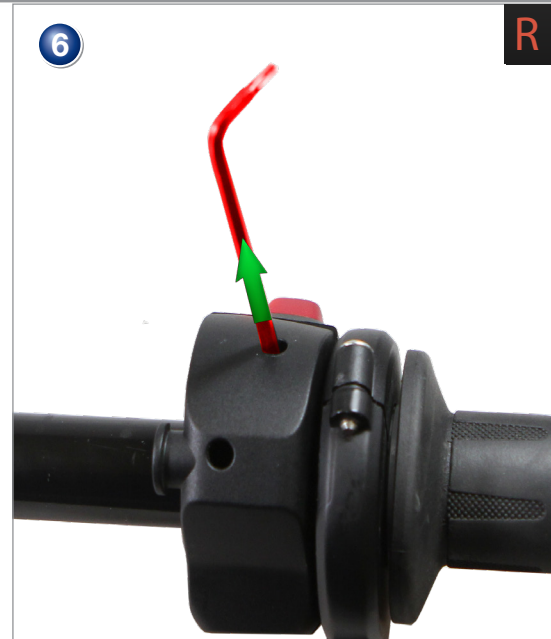

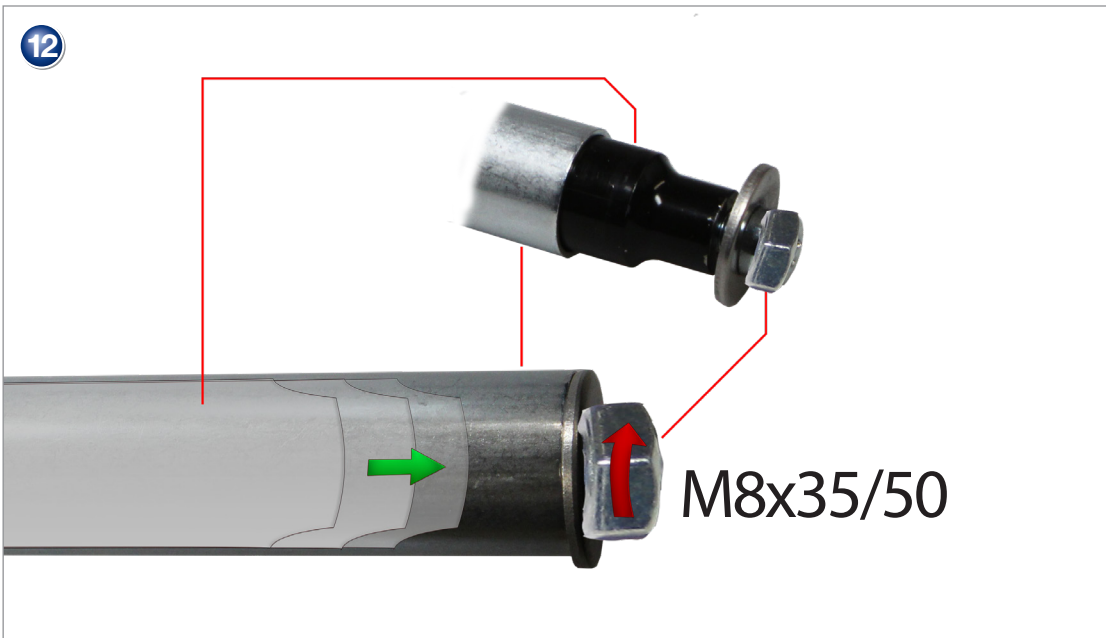

14

Einfetten / grease

M10x35

50Nm Drehmoment
Torque

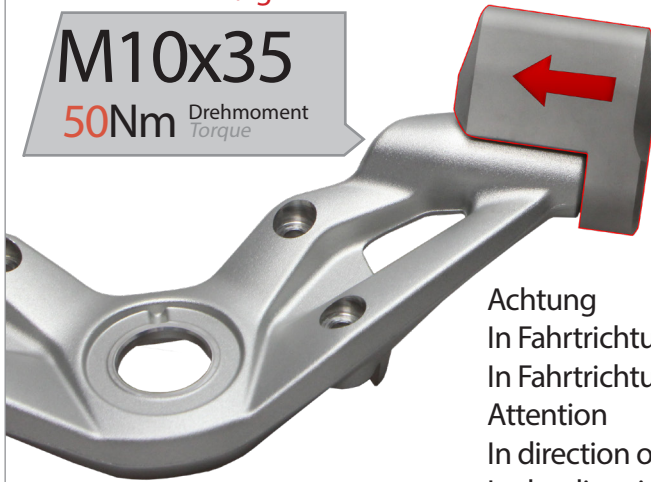

Achtung
In Fahrtrichtung rechts - normales Gewinde,
In Fahrtrichtung links - links Gewinde.
Attention
In direction of travel right - normal thread,
In the direction of travel left - left thread.

15

Richten Sie die Lenkererhöhung vor dem Anziehen der Schraube aus.
Ein Verstellen ist im Anschluss nicht mehr möglich. Beachten Sie auch die Stellung der Armaturen.
Adjust the height of the handlebars before tightening the screw. Adjustment is no longer possible in the connection. Also observe the position of the fittings.



16

Original

40Nm Drehmoment
Torque

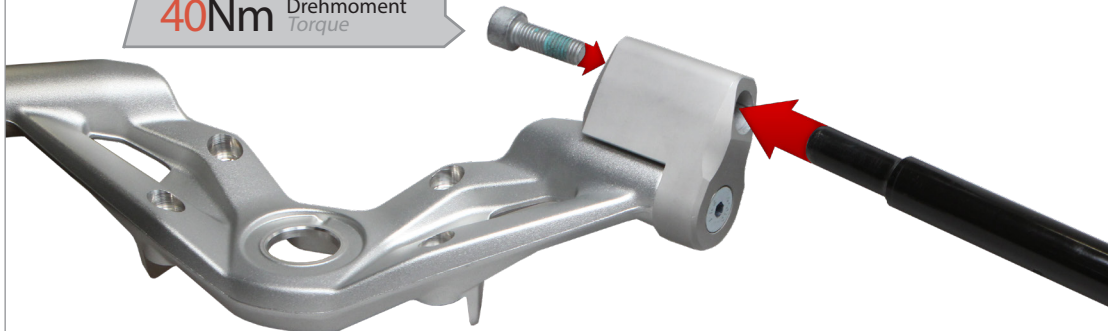

17



Bauen Sie alles in umgekehrter Reihenfolge wieder zusammen.
Reassemble in reverse order.