

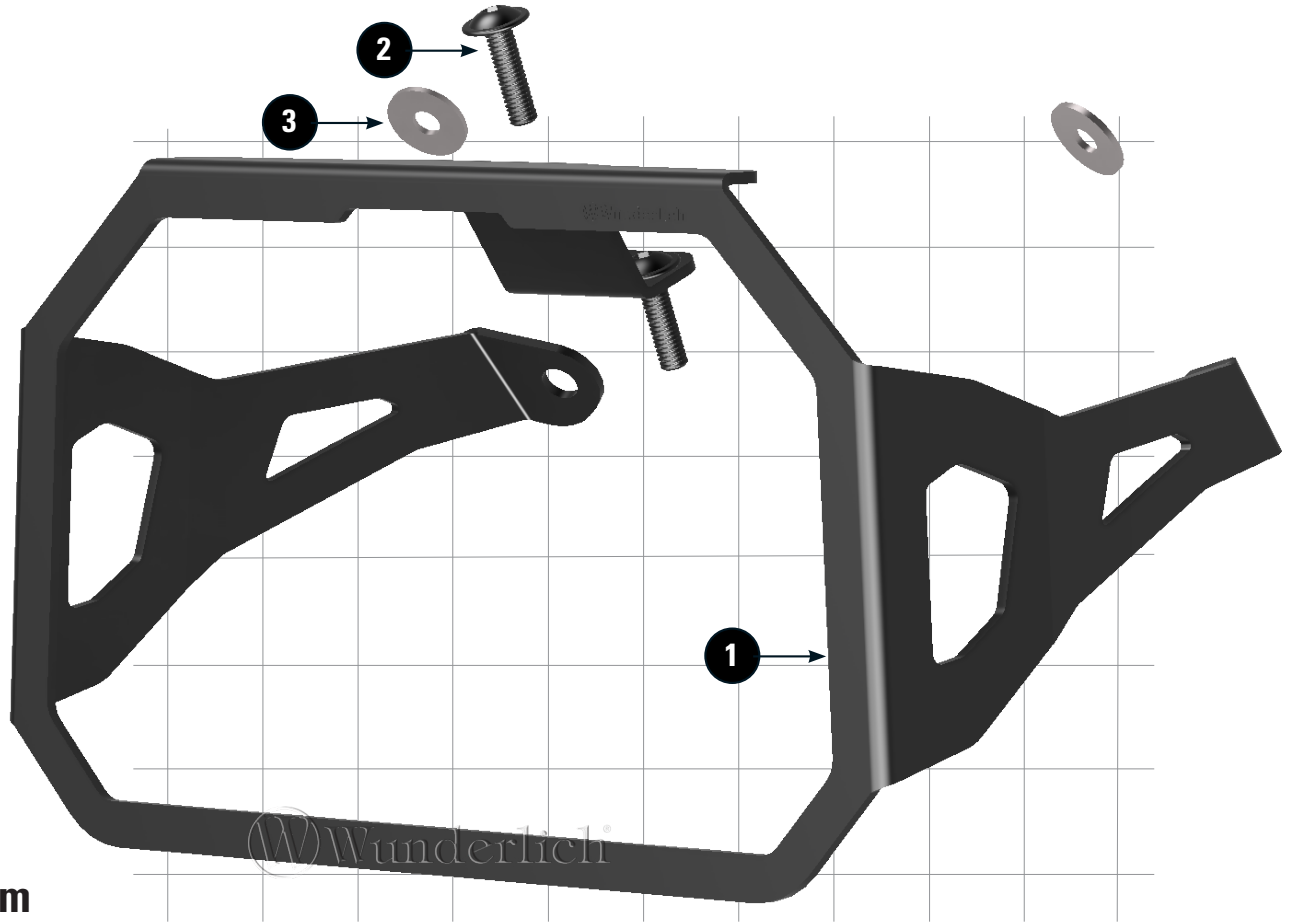







TFT-DISPLAY DIEBSTAHLSCHUTZ

TFT display theft protection | Protection contre le vol pour écran TFT | Protección antirrobo para pantalla TFT | Protezione antifurto per display TFT

Art.-Nr: **21056-002**



LEGENDE/KEY/FILE LÉGENDE

-  **Anbau Tipp**
Fitting tip
Astuce de montage
-  **Achtung**
Attention
Attention
-  **Vergrößerung**
Magnification
Grossissement
-  **Montagepaste**
Fitting lubricant
Lubrifiant de montage
-  **Schraube**
Screw
Vis
-  **Schraubensicherung**
Thread locking fluid
Freinilets
-  **Drehmoment**
Torque
Torque
-  **Reiniger**
Cleaner
Nettoyant



| # | Bauteil <i>component</i> <i>composant</i> | DE Die Farben der Abbildungen dienen nur der Veranschaulichung. EN The colors are for illustrating purposes only. FR Les couleurs utilisées sont à titre indicatif seulement. | DIN | ISO | Menge <i>quantity</i> <i>quantité</i> |
|---|---|---|------|------|---|
| 1 | TFT Diebstahlschutz / TFT theft protection | | | | 1 |
| 2 | Linsenkopfschraube / Lens head screw M5x18 | | 7381 | 7381 | 2 |
| 3 | U-Scheibe / Washer M5 | | 9021 | 7093 | 2 |



1



2

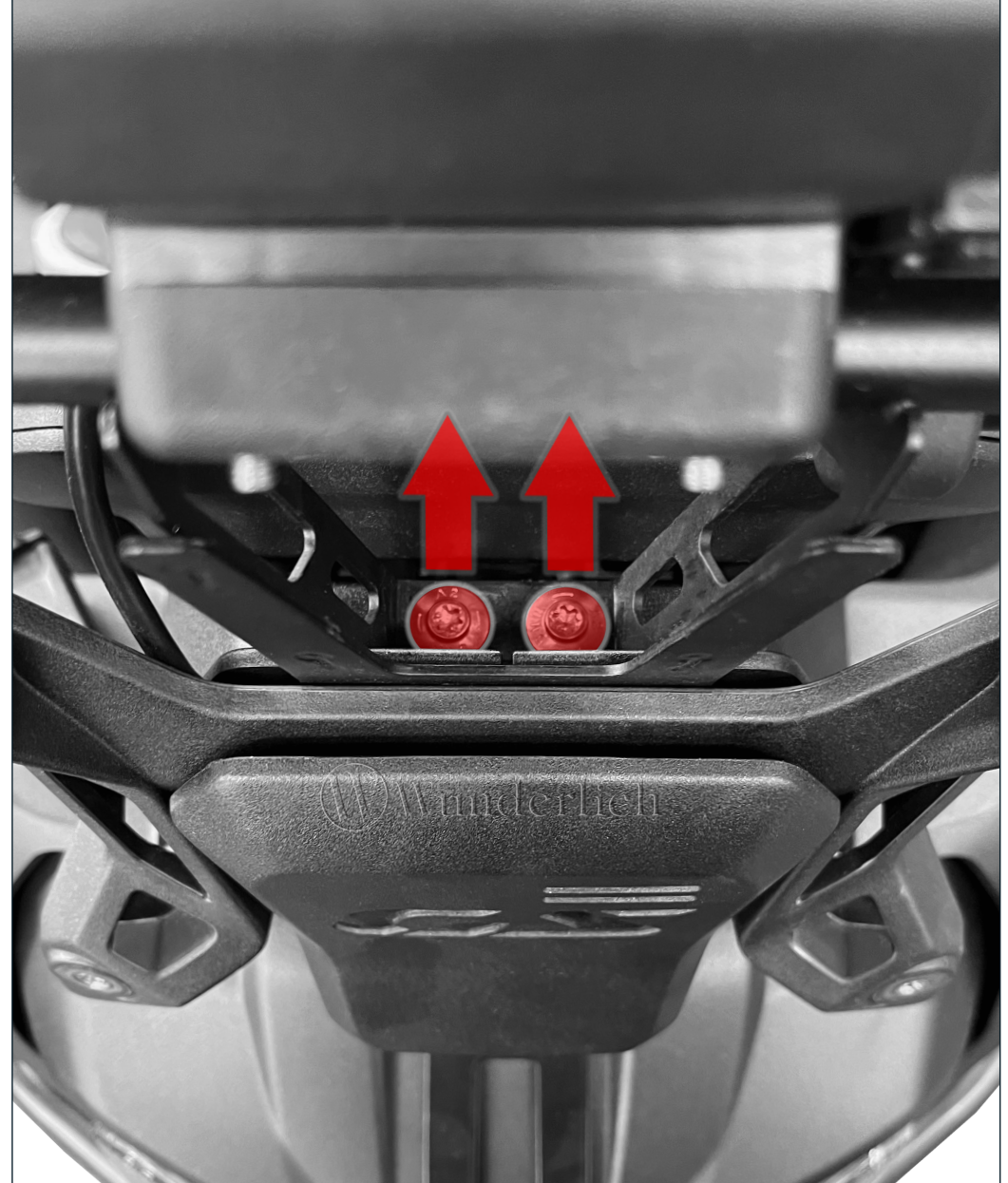

3

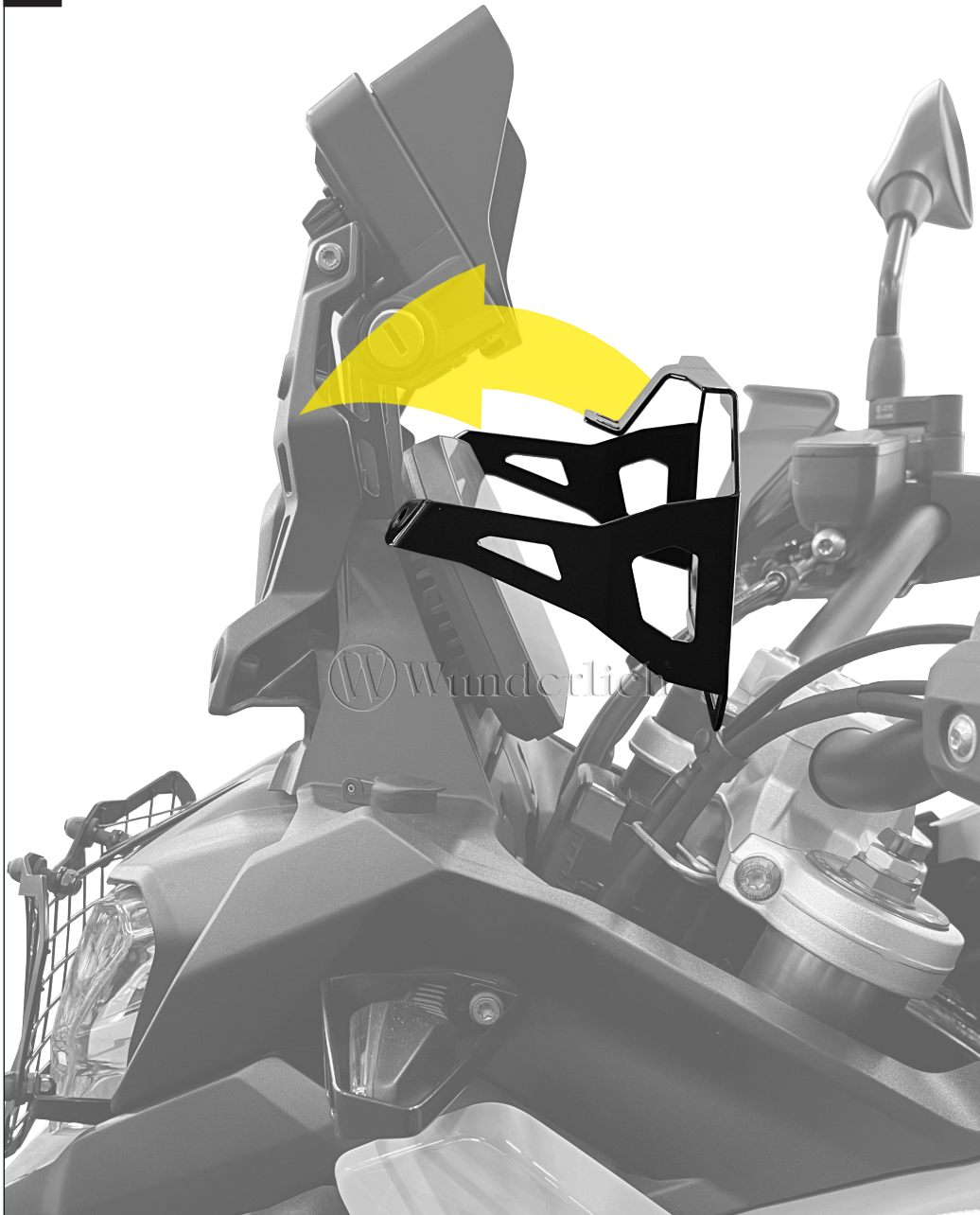

4

**SCHRAUBEN LOOSE VORMONTIEREN.
PRE-ASSEMBLE THE SCREWS LOOSELY.
PRÉMONTIEZ LES VIS SANS LES SERRER.**

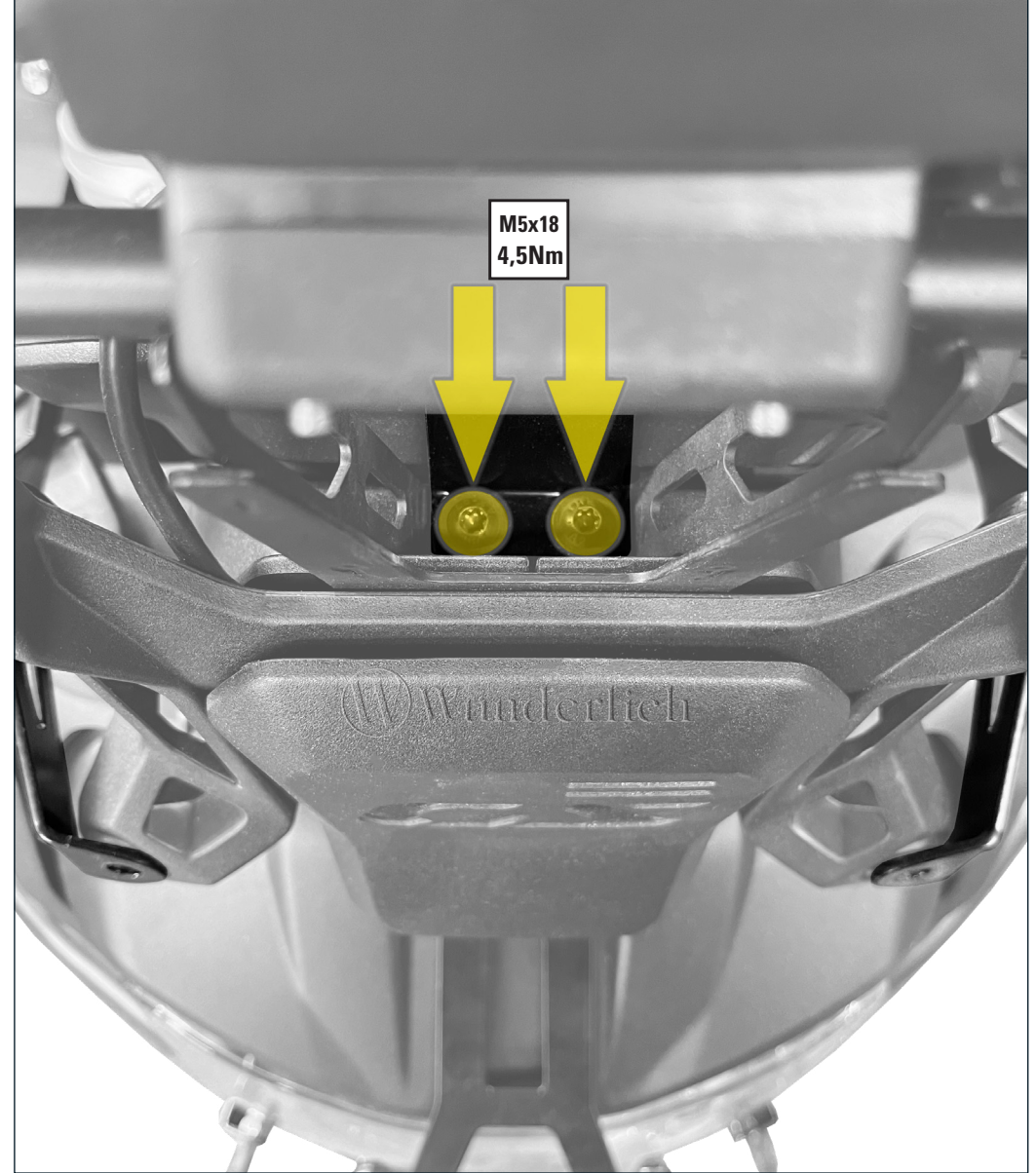

5



**DIEBSTAHLSCHUTZ AUSRICHTEN UND SCHRAUBEN AUS BILD 4 FESTZIEHEN.
ALIGN THE THEFT PROTECTION AND TIGHTEN THE SCREWS FROM IMAGE 4.
ALIGNER LA PROTECTION CONTRE LE VOL ET SERREZ LES VIS DE L'IMAGE 4.**

6

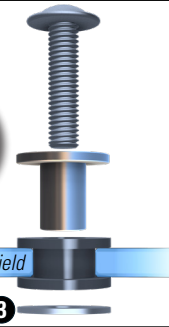

Windschild/windshield

**DIE UNTERLEGSCHIBE 3 WIRD NUR AN DEN OBEREN VERSCHRAUBPUNKTEN DER SCHEIBE BENÖTIGT.
WASHER 3 IS ONLY REQUIRED AT THE UPPER MOUNTING POINTS OF THE SCREEN.
LA RONDELLE 3 N'EST NÉCESSAIRE QU'ÀUX POINTS DE FIXATION SUPÉRIEURS DE L'ÉCRAN.**

